

SENA



M1 EVO

SMART MOUNTAIN BIKE HELMET

USER'S GUIDE

TABLE OF CONTENTS

1.	ABOUT THE M1 EVO SMART MOUNTAIN BIKE HELMET	4
1.1	General Information	4
1.2	Product Details	5
1.3	Package Contents	5
1.4	Wearing the Helmet	6
1.4.1	How to Wear The Helmet	6
1.4.2	Helmet Fitment Check	8
2.	GETTING STARTED: BLUETOOTH SYSTEM	9
2.1	Downloadable Sena Software	9
2.1.1	Sena Cycling App	9
2.1.2	Sena Device Manager	9
2.2	Button Function	10
2.3	Legend	10
2.4	Powering On and Off	10
2.5	Charging	10
2.6	Checking the Battery Level	11
2.7	Volume Adjustment	12
3.	PAIRING THE BLUETOOTH SYSTEM WITH OTHER BLUETOOTH DEVICES	13
3.1	Phone Pairing	13
3.1.1	Initially Pairing the M1 EVO	13
3.1.2	Pairing When the M1 EVO is Turned Off	14
3.1.3	Pairing When the M1 EVO is Turned On	14
3.2	Second Mobile Phone Pairing - Second Mobile Phone and GPS	15
4.	MOBILE PHONE USAGE	16
4.1	Making and Answering Calls	16
4.2	HD Voice (Always On)	16

5. STEREO MUSIC	17
5.1 Bluetooth Stereo Music	17
6. MESH INTERCOM	18
6.1 What is Mesh Intercom?	18
6.2 Starting Mesh Intercom	19
6.3 Mic Enable/Disable (Default: Enable)	19
6.4 Channel Setting (Default: 1)	19
6.4.1 Using the Button	19
6.4.2 Using the Sena Cycling App	20
7. LED TAILLIGHT	21
7.1 Using the SENA Button	21
7.2 Using the Sena Cycling App	21
8. FUNCTION PRIORITY AND FIRMWARE UPGRADES	22
8.1 Function Priority	22
8.2 Firmware Upgrades	22
9. CONFIGURATION SETTING	23
9.1 Bluetooth System Configuration Menu	23
9.2 Software Configuration Setting	23
9.2.1 Headset Language	24
9.2.2 Voice Prompt (Default: Enable)	24
9.2.3 Advanced Noise Control™ (Always on)	24
10. TROUBLESHOOTING	25
10.1 Fault Reset	25
10.2 Factory Reset	25
11. MAINTENANCE AND CARE	26

1. ABOUT THE M1 EVO SMART MOUNTAIN BIKE HELMET

1.1 General Information

This product is a mountain bike helmet. Do not use it for any other purpose than riding a bicycle. If you use the helmet for anything else, it may not provide sufficient protection in an accident.

Sena recommends that you choose a helmet which provides the most coverage, as a helmet that covers more of your head may provide additional protection. Always wear your mountain bike helmet low in the front to protect the forehead, as this area is most likely to be impacted in a bicycle crash. Make sure the helmet fits comfortably and is tightly fastened at all times.

WARNING

- Your helmet will not protect against injury in all types of accidents. Even while wearing a helmet, low speed accidents may result in serious head injury or death. A mountain bike helmet will not protect against injuries to the spine, neck or face. In the event of any impact, do not use this helmet. There may be damage invisible to you, which may reduce the ability of the helmet to reduce the harmful effects of a blow to the head. Such helmet should be returned to Sena for inspection, or destroyed and replaced.
- Do not modify or remove any original part of the helmet. Do not use heat damaged helmets. Heat damaged helmets will appear to have uneven or have bubbly surfaces.
- This User's Guide and the stickers inside your helmet contain many instructions and warnings about your helmet. It is important for you to understand everything communicated in them before your first ride. If you do not, please contact your authorized Sena Retailer with any questions you may have. Failure to follow any of the provided instructions or warnings could void your warranty, and most importantly, could result in severe personal injury or death. If you are a parent or guardian and this helmet is for your child, please take the time to read this manual as you should make sure your child understands everything in this User's Guide.

1.2 Product Details

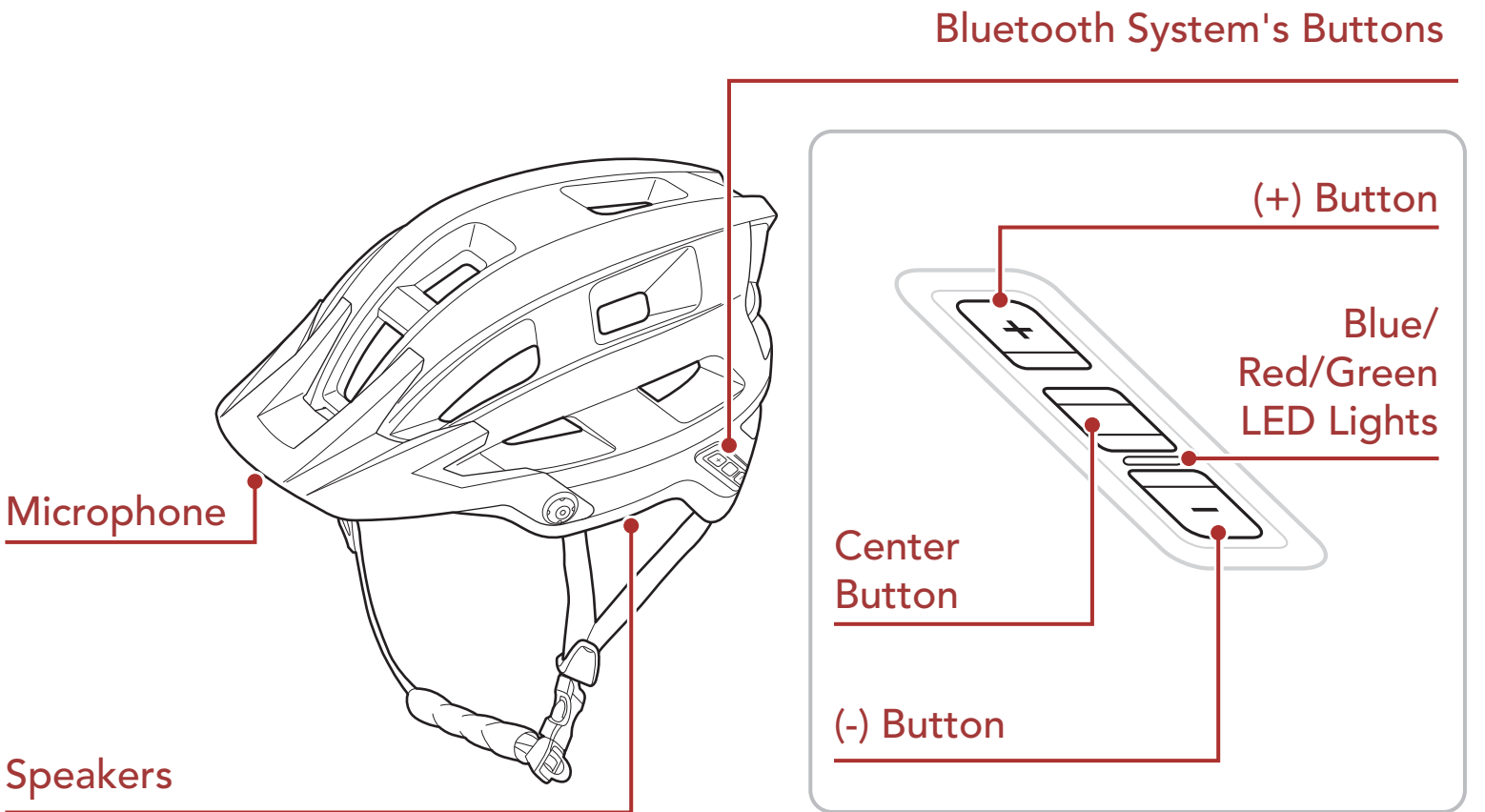

SENA Button

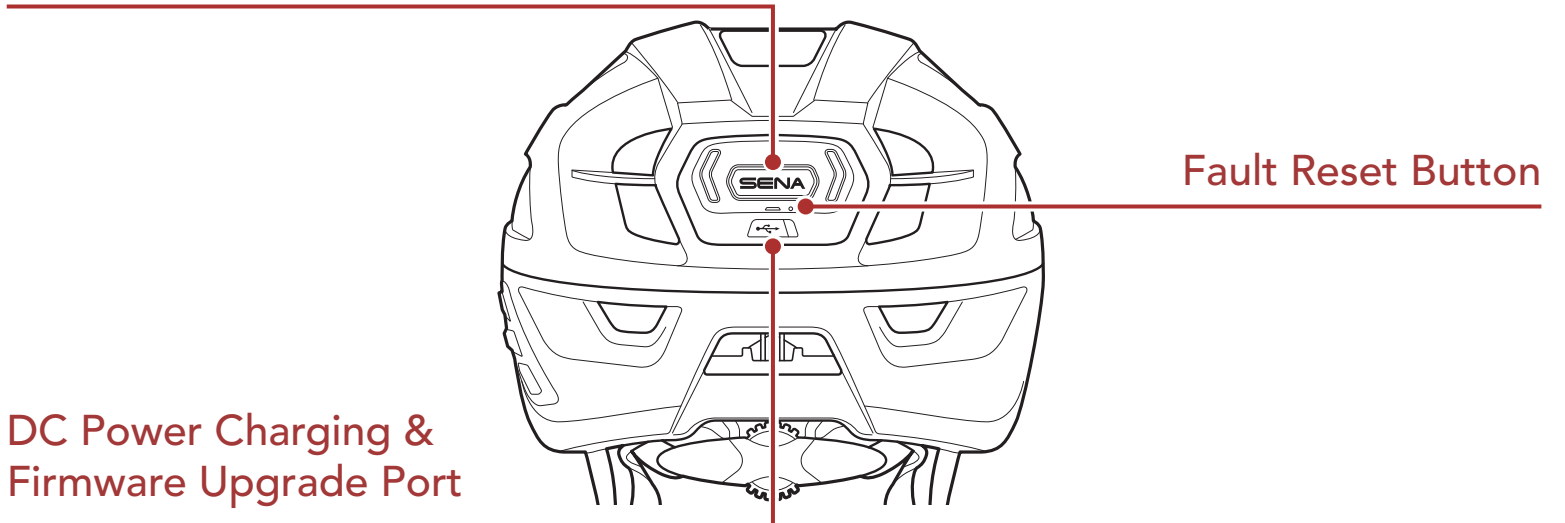

1.3 Package Contents



M1 EVO Helmet



USB Power & Data Cable (USB-C)



Helmet Pouch

1.4 Wearing the Helmet

1.4.1 How to Wear The Helmet

For proper use, the helmet must sit level on the head and low on the forehead. The Sena helmet uses a simple, quick-release buckle system that, once adjusted, can be buckled and unbuckled without changing the adjustment. For proper use, the straps must be tight and evenly tensioned.

To properly wear your helmet:

1. Position the helmet on your head with the front covering your forehead. If the helmet is tipped back and is not covering your forehead then the helmet is not in the proper position.
2. Position the strap adjuster centered, just below your ears.

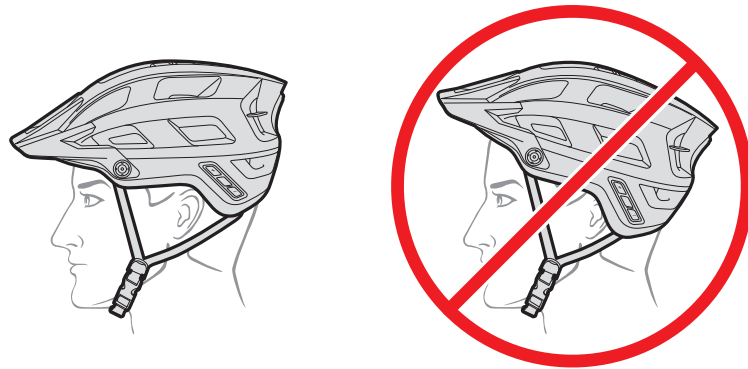

⚠ WARNING: Always wear the helmet in the proper position on your head with the front of the helmet covering your forehead for maximum protection. Never wear the helmet tipped back as the helmet will be in the improper position causing your forehead to be exposed. All fitment adjustments need to be made with the helmet in the proper position.

3. Position the helmet low on your forehead with the buckle under the chin and back against the throat. The straps should fit comfortably around both ears.
4. After removing the chinstrap pad, adjust the chinstrap tension at the buckle with the strap adjuster in the proper position. Adjust the tension so the chinstrap is tight and comfortable by pulling the chinstrap end through the buckle to either tighten or loosen as needed.

Chinstrap Pad

Buckle

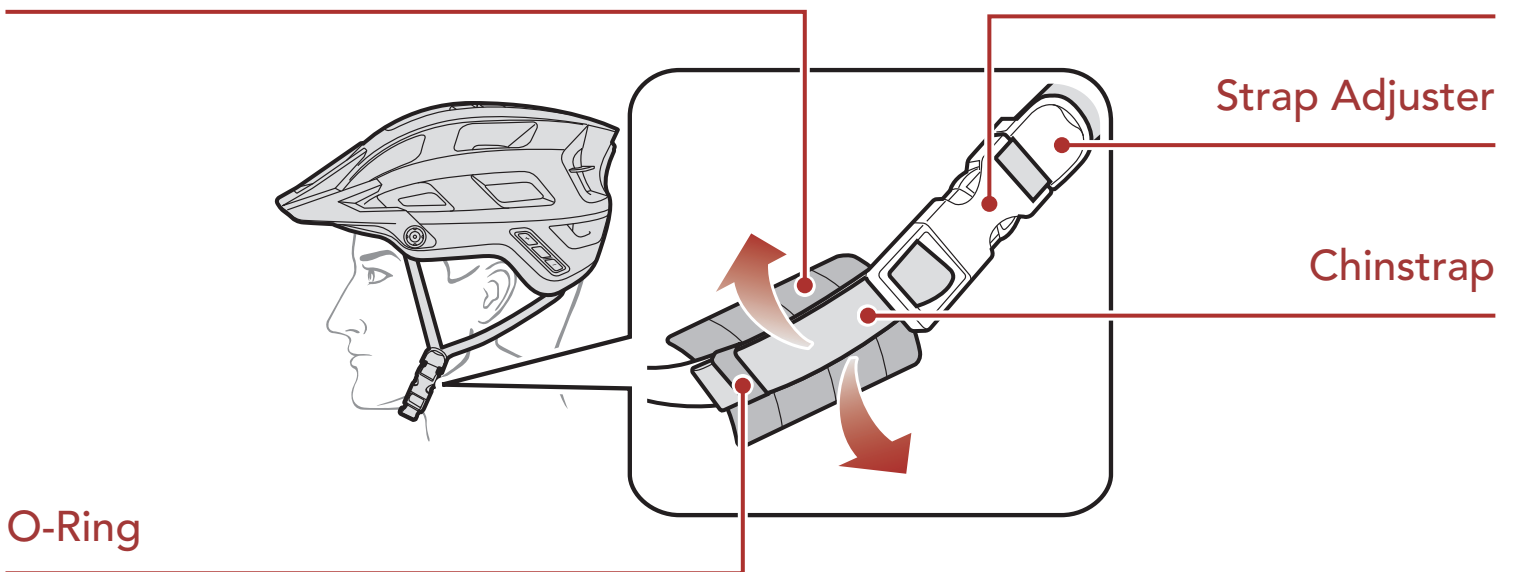

5. Secure the excess strap with O-ring and then attach the chinstrap pad. Always wear the helmet with the chinstrap buckle fastened and the chinstrap pulled tight and positioned back against the throat. With the strap buckled and the helmet positioned, you should feel the chinstrap pull firmly against your chin as you open your mouth. When properly adjusted the helmet will wrap around your head and cradle it with firm, but comfortable pressure.

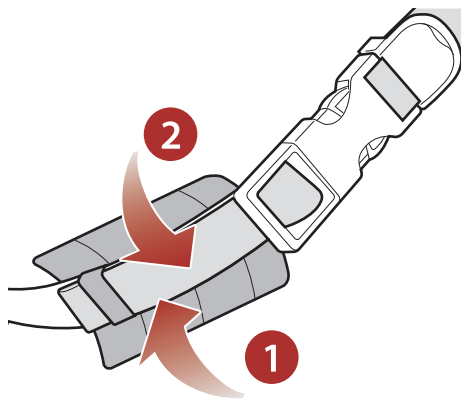

6. Your helmet is equipped with an adjustable retention system which helps stabilize the helmet in the correct position when you ride. When wearing the helmet, turn the retention system knob clockwise to tighten the helmet or counterclockwise to loosen the helmet.

7. To change the height of the retention system, firmly pull or push the retention system upward or downward to a different position.

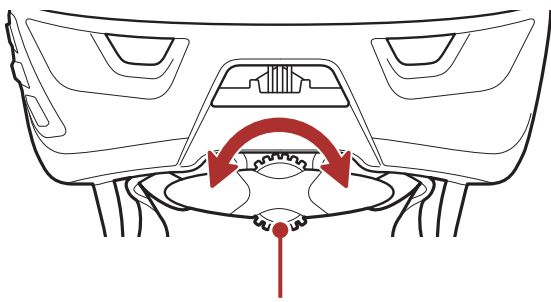

Retention System Knob

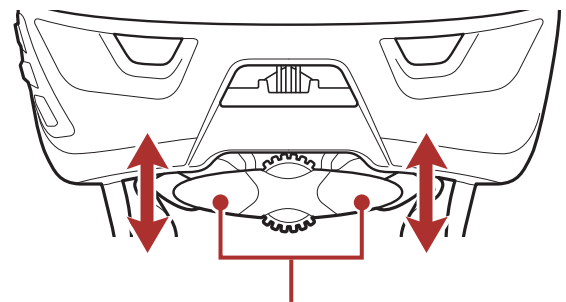

Retention System

⚠ WARNING: For maximum protection, this helmet must be fitted and attached properly to the wearer's head in accordance with the following instructions. If after adjustment the helmet does not fit properly, do not use the helmet. Return it to the retailer or Sena.

1.4.2 Helmet Fitment Check

With the retention system knob turned clockwise until comfortably tight and the chinstrap buckled under the chin and back against the throat, grab the helmet with both hands and try to remove it by rolling the helmet forward and backward as far as you can. This is an important test to ensure that the helmet fits correctly. When you do this, you should feel the chinstrap pull against the underside of your chin and the helmet will resist any movement. If this isn't the case, tighten the chinstrap and try it again until this happens. If you cannot achieve the proper fit, **DO NOT USE THIS HELMET**. Replace it with a different size until the correct fit is achieved.

Also, for a proper **Helmet Fitment Check** if you can roll the helmet forward such that it blocks your vision or if you can roll the helmet backwards such that your forehead is not covered, tighten the chinstrap and the retention system and try again until you cannot roll the helmet forward or backwards.

WARNING

- Do not wear anything underneath your helmet, such as a cap, hood, bundled hair, headphones, or barrettes, as the helmet may loosen or come off. Do not wear anyone else's helmet and don't loan your helmet to anyone else.
- Always make sure the buckle is properly fastened before you ride. Failure to follow this instruction could result in serious personal injury, as the helmet may not stay in position while riding or during a fall. For proper use, make sure the loose end of the chinstrap is tucked through the rubber "O" ring.
- Check for proper fit and adjustment often, including each time you wear it, and periodically during use.
- This helmet has been designed for recreational bicycling. This helmet has not been approved and is not intended for extreme uses such as downhill racing at high speeds, jumping or leaping with a fully suspended bicycle, snow sports, water sports, motor sports, street hockey, playground activities, or other activities where face, ear, or greater protection or coverage is desired.
- Always wear a helmet when bicycling. When you get off your bicycle, remove your helmet. Do not wear a helmet while climbing trees, in play areas, on playground equipment, or, at any time while not riding a bicycle. Parents: Instruct children to follow this warning. Failure to follow this warning could result in serious personal injury, death or death by strangulation.

2. GETTING STARTED: BLUETOOTH SYSTEM

2.1 Downloadable Sena Software

2.1.1 Sena Cycling App

By simply pairing your phone with your Bluetooth system, you can use the **Sena Cycling App** for quicker, easier set up and management.



- Download the **Sena Cycling App** on **Google Play Store** or **App Store**.

2.1.2 Sena Device Manager

The **Sena Device Manager** allows you to upgrade the firmware and configure its settings directly from your PC or Apple computer. Download the **Sena Device Manager** from **sena.com**.

[Click Here to Visit sena.com](https://www.sena.com)

NOTICE

- This **User Guide (Version 2.0)** explains how to operate the M1 EVO with **firmware version 2.0 or higher**.
- For the operation of the M1 EVO with **a firmware version lower than 2.0**, refer to the **M1 EVO User Guide (Version 1.0.1)**.

2.2 Button Function

Bluetooth System's Buttons

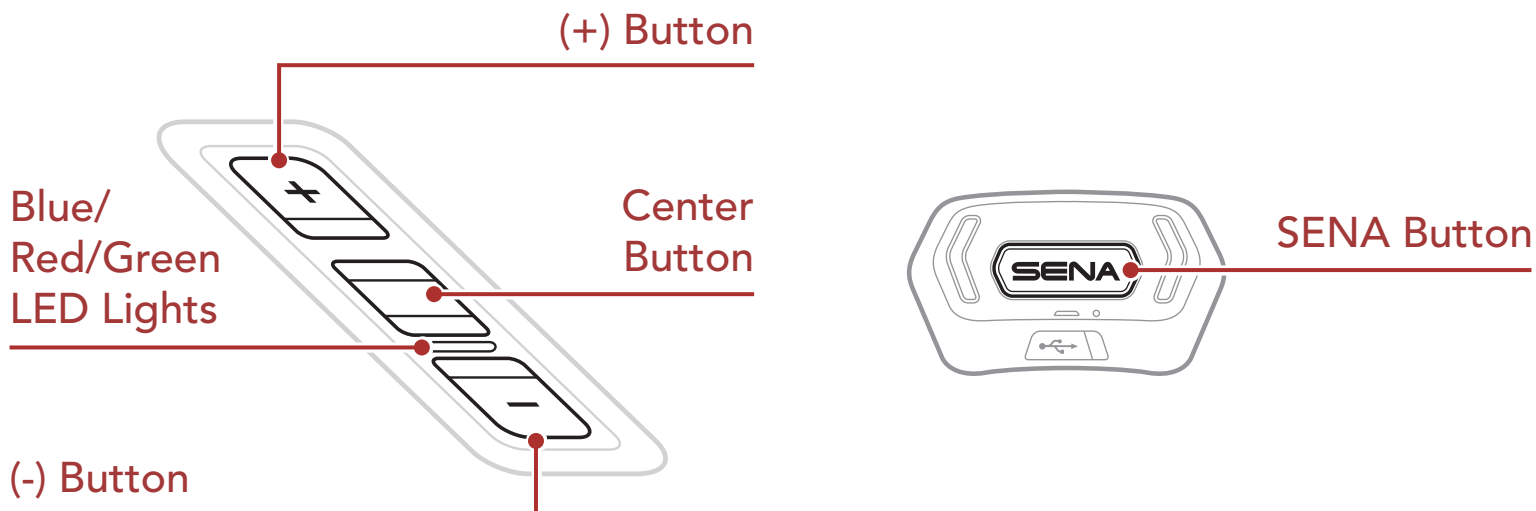

2.3 Legend

(TAP 1x) Tap button the specified number of times

(HOLD 10s) Press and Hold button for the specified amount of time

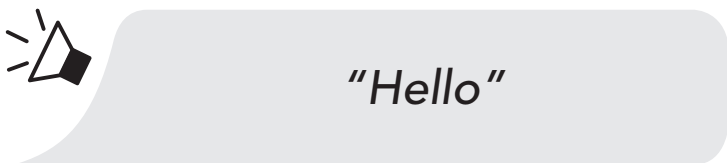

Audible prompt

2.4 Powering On and Off

Powering On



Powering Off

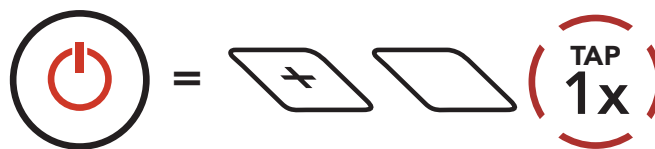

2.5 Charging

Charging the Bluetooth System

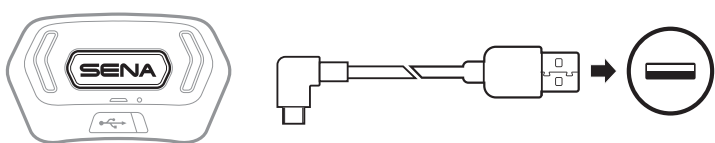

Depending upon the charging method, the Bluetooth system will be fully charged in about 3 hours.

Note:

- The Bluetooth system includes a **Fast Charging** feature which allows it to charge quickly over a short period of time. For example, a user can get up to 2.0 hours of Mesh communication after charging the Bluetooth system for 20 minutes.
- Please make sure to take off your helmet while charging. The Bluetooth system automatically turns off during charging.
- Any 3rd party USB charger can be used with Sena products if the charger is approved by either the FCC, CE, IC, or other locally approved agencies.
- Use of a non-approved charger may cause fire, explosion, leakage, and other hazards which may also reduce the life time or performance of the battery.
- The **M1 EVO** is compatible with 5 V input USB-charged devices only.

2.6 Checking the Battery Level

Instruction is for when powering the Bluetooth system on.

Visual Method

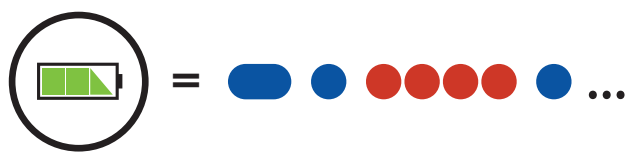
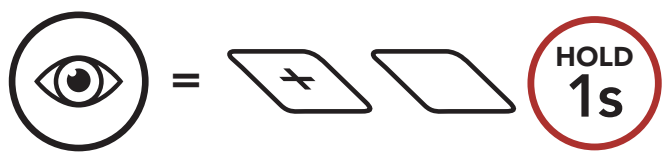

HIGH

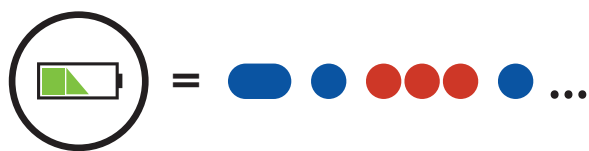

MEDIUM



LOW

Note:

- The battery performance may be reduced over time with usage.
- Battery life may vary depending on conditions, environmental factors, functions of the product in use, and devices used with it.

2.7 Volume Adjustment

Volume is set and maintained independently at different levels for each audio source, even when the Bluetooth system is rebooted.

Volume Up

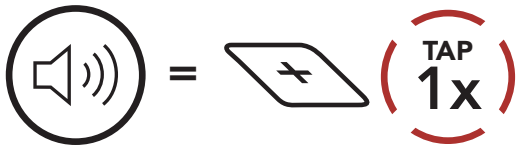

Volume Down

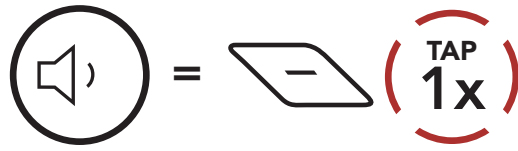

3. PAIRING THE BLUETOOTH SYSTEM WITH OTHER BLUETOOTH DEVICES

When using the Bluetooth system with other Bluetooth devices for the first time, they will need to be “paired.” This enables them to recognize and communicate with one another whenever they are within range.

The pairing operation is required only once for each Bluetooth device. The Bluetooth system can pair with multiple Bluetooth devices such as a mobile phone, GPS, or MP3 player via Mobile Phone Pairing and Second Mobile Phone Pairing.

3.1 Phone Pairing

There are three ways to pair the phone.

3.1.1 Initially Pairing the M1 EVO

The Bluetooth system will automatically enter the phone pairing mode when you initially turn on the Bluetooth system or in the following situation:

- Rebooting after executing **Factory Reset**

1. Press and hold the **Center Button** and the **(+) Button** for **1 second**.

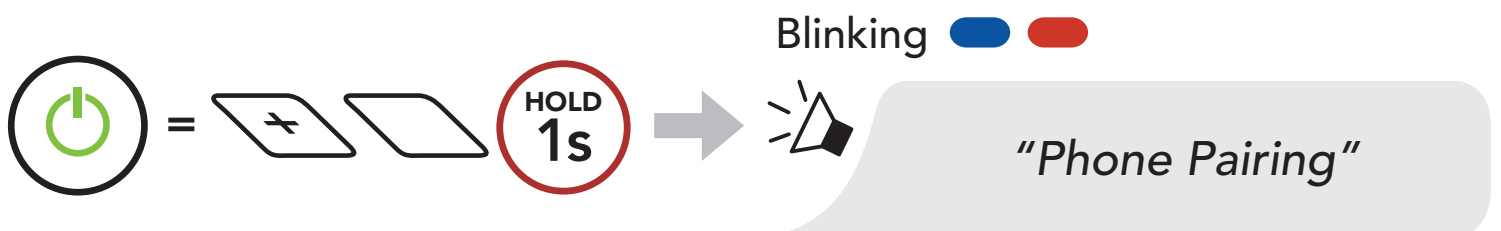

2. Select **M1 EVO** in the list of Bluetooth devices detected. If your mobile phone asks for a PIN, enter 0000.



Note:

- The phone pairing mode lasts for **3 minutes**.
- To cancel phone pairing, tap the **Center Button**.

3.1.2 Pairing When the M1 EVO is Turned Off

1. While the Bluetooth system is off, press and hold the **Center Button** and the **(+) Button** until the LED flashes red and blue alternately and you hear a voice prompt, **"Phone pairing"**.

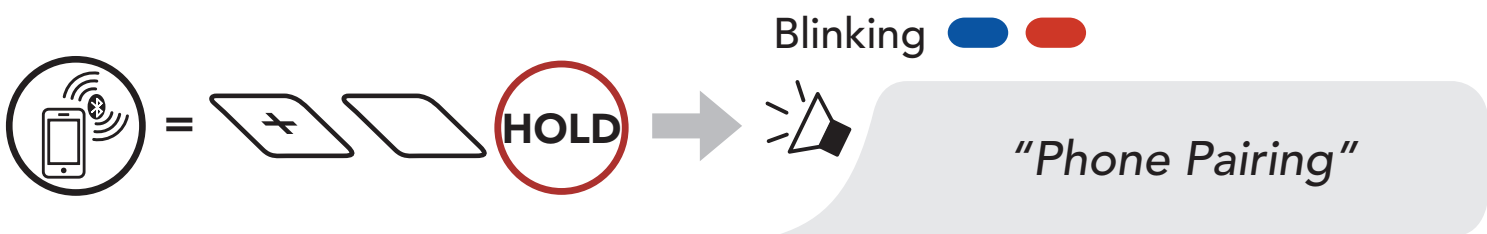

2. Select **M1 EVO** in the list of Bluetooth devices detected. If your mobile phone asks for a PIN, enter 0000.



3.1.3 Pairing When the M1 EVO is Turned On

1. While the Bluetooth system is on, press and hold the **Center Button** for **5 seconds**.

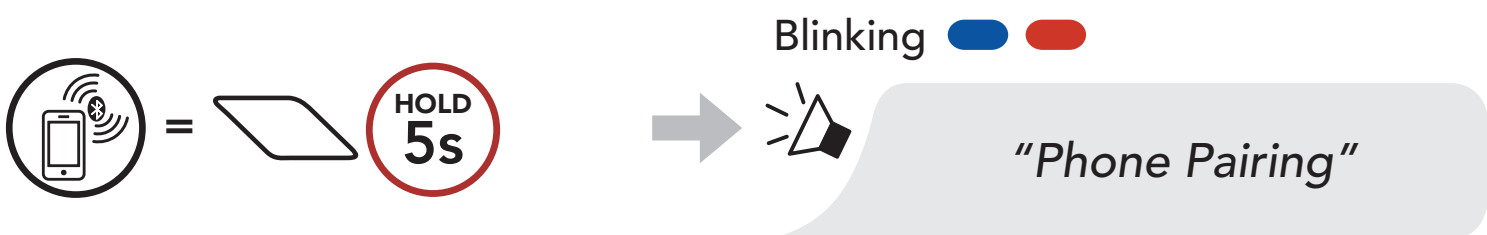

2. Select **M1 EVO** in the list of Bluetooth devices detected. If your mobile phone asks for a PIN, enter 0000.



3.2 Second Mobile Phone Pairing - Second Mobile Phone and GPS

1. Press and hold the **Center Button** for **10 seconds**.



2. Tap the **(+) Button**.

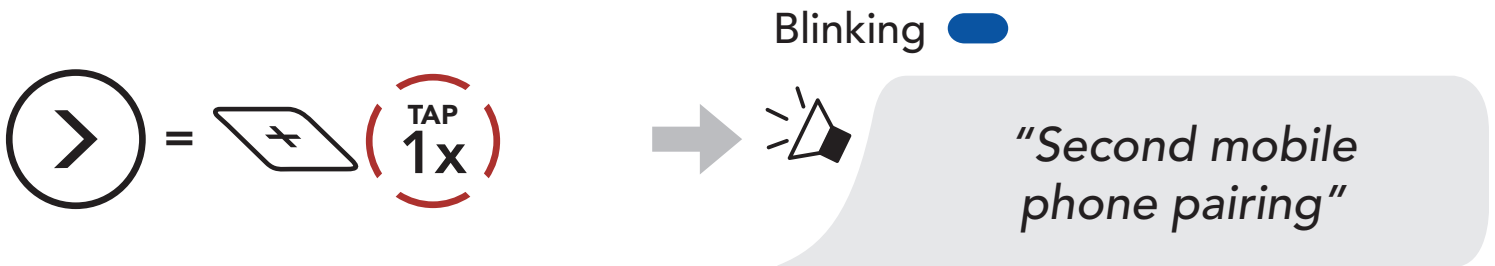

3. Select **M1 EVO** in the list of Bluetooth devices detected. If your Bluetooth device asks for a PIN, enter 0000.



4. MOBILE PHONE USAGE

4.1 Making and Answering Calls

Answer a Call

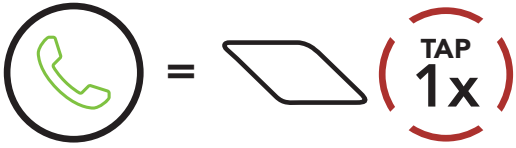

End/Reject a Call

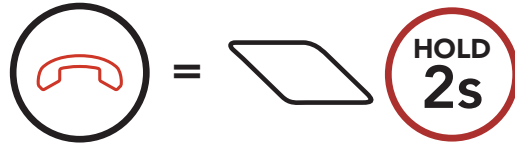

Make a Call with Voice Dialer



4.2 HD Voice (Always On)

HD Voice allows you to communicate in high-definition during phone calls. This feature increases the quality so that the audio will be crisp and clear during phone call conversations.

Note: Refer to the manufacturer of your Bluetooth device that will be connected to the Bluetooth system to see if it supports **HD Voice**.

5. STEREO MUSIC

5.1 Bluetooth Stereo Music

Play/Pause Music

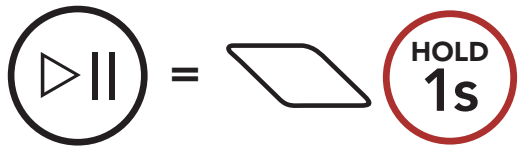

Volume Up/Down

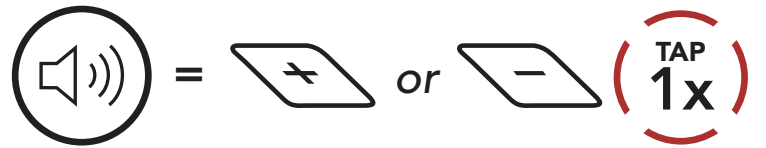

Next Track

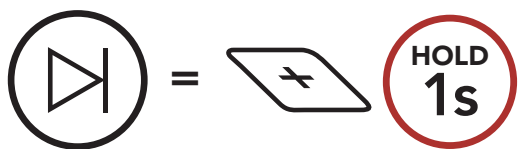

Previous Track



6. MESH INTERCOM

6.1 What is Mesh Intercom?

Sena proposes using **Mesh Intercom™**, which provides instant and effortless bike-to-bike communication without a pre-grouping process.

Mesh Intercom allows riders to connect and communicate with nearby users without the need to pair each Bluetooth system together.

The working distance between each **M1 EVO** in **Mesh Intercom** can be up to 900 m (0.5 mi) in open terrain. In open terrain, the **Mesh** can be extended up to 3.6 km (2.0 mi) between a minimum of 6 users.

A user can select with channel to use (1-9) using the Bluetooth system.

Separate groups can communicate freely within a channel.

Within the same channel in **Mesh Intercom**, 6 users can talk at the same time for an optimized conversation.

Mesh Intercom

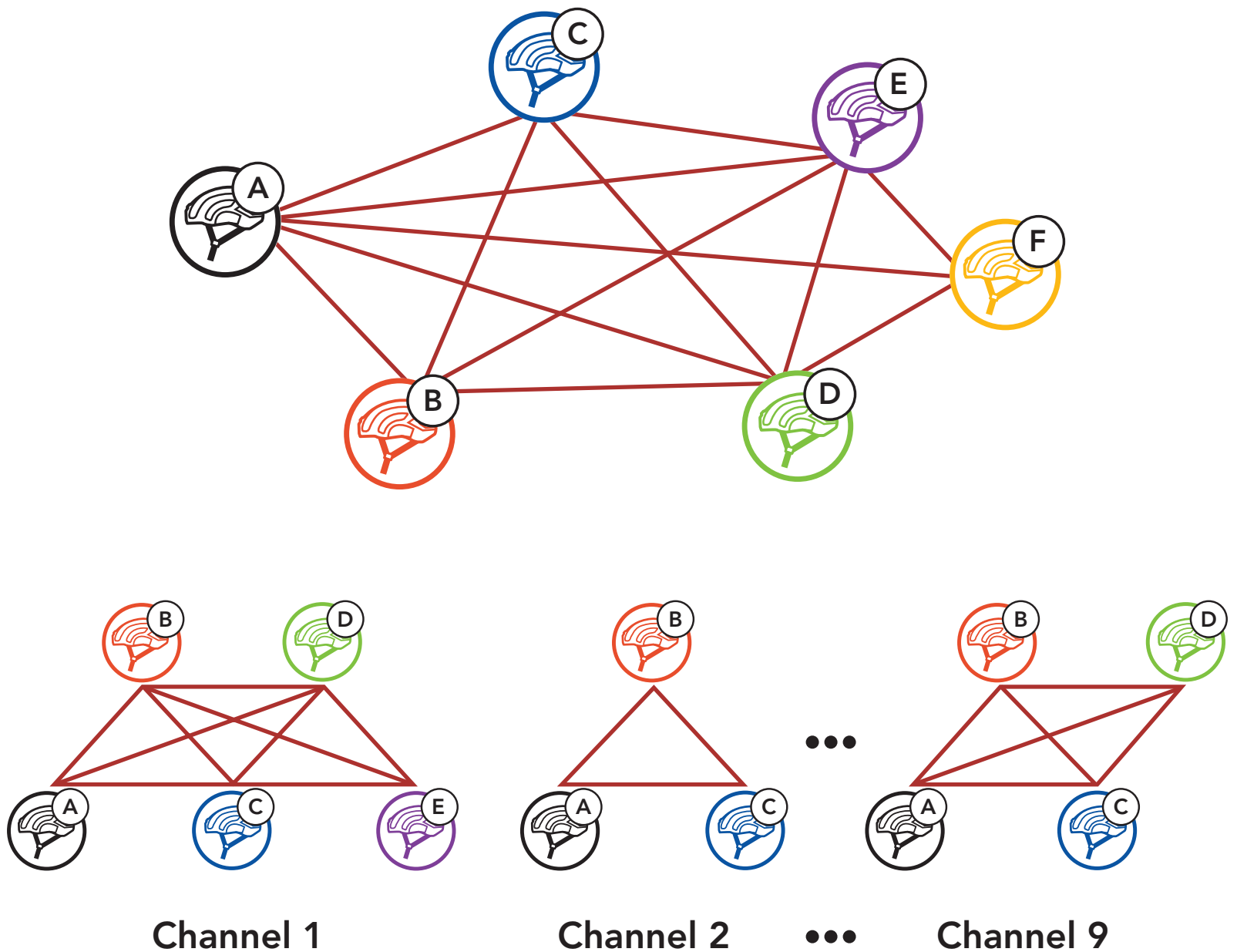

6.2 Starting Mesh Intercom

When **Mesh Intercom** is enabled, the **M1 EVO** will automatically connect to nearby **M1 EVO** users and allow them to talk to each other by pressing the **Center Button**.

Mesh Intercom On

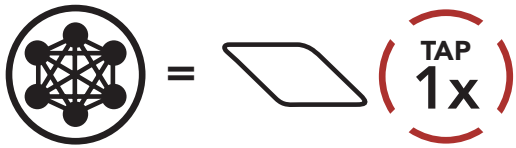

"Mesh intercom on"

Mesh Intercom Off

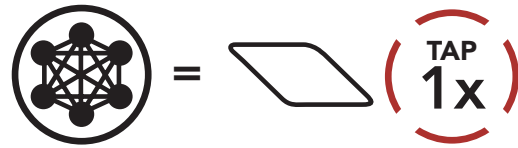

"Mesh intercom off"

6.3 Mic Enable/Disable (Default: Enable)

Users can enable/disable the microphone when communicating in a **Mesh Intercom**.

Enable/Disable the Microphone



6.4 Channel Setting (Default: 1)

If the **Mesh Intercom** communication experiences interference because other groups are also using **channel 1**, change the channel. You can select one of 1 to 9 channels.

6.4.1 Using the Button

1. Enter into the **Channel Setting**.

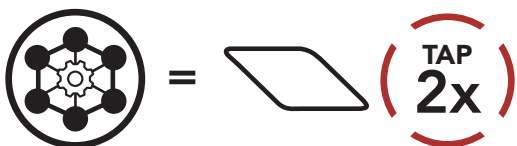

"Channel setting, 1"

2. Navigate between the channel.

(1 → 2 → ●●● → 8 → 9 → Exit → 1 → ●●●)

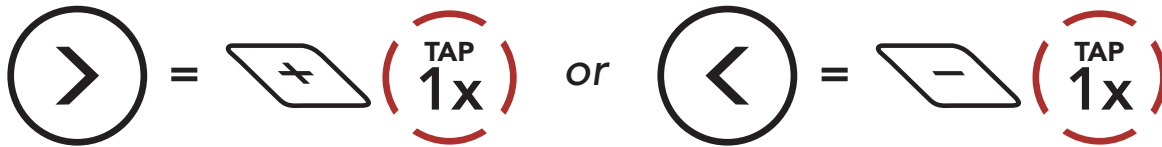

"#"

3. Save the channel.



"Channel is set, channel #"

4. To exit the **Channel Setting**, tap the **(+) Button** or the **(-) Button** until you hear a voice prompt, **"Exit"**, and tap the **Center Button**.

Note:

- **Channel Setting** always starts with channel 1.
- If you do not press any button within for approximately **10 seconds** in a specific channel, the channel will be automatically saved.
- The channel will be remembered even if you turn off the **M1 EVO**.

6.4.2 Using the Sena Cycling App

You can select the channel through the **Sena Cycling App**.

7. LED TAILLIGHT

There is a Red LED on the back of the helmet to ensure you stand out on the road.

7.1 Using the SENA Button

LED On and Solid



Night Flash



Day Flash



LED Off



Note: Do not tap the button continuously.

7.2 Using the Sena Cycling App

You can control the LED Taillight through the **Sena Cycling App**.

8. FUNCTION PRIORITY AND FIRMWARE UPGRADES

8.1 Function Priority

The Bluetooth system operates in the following order of priority:

- (highest)** Mobile phone
- Mesh Intercom
- (lowest)** Bluetooth stereo music

A lower priority function is always interrupted by a higher priority function.

8.2 Firmware Upgrades

The Bluetooth system supports firmware upgrades. You can upgrade the firmware using the **Sena Device Manager**. Please visit **sena.com** to check for the latest software downloads.

[Click Here to Visit sena.com](https://sena.com)

9. CONFIGURATION SETTING

9.1 Bluetooth System Configuration Menu

Accessing the Configuration Menu

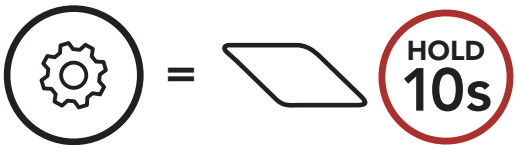

Navigating Between Menu Options

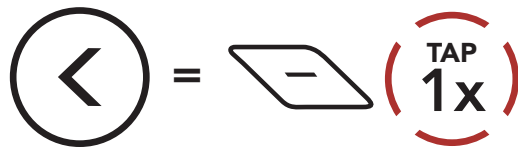
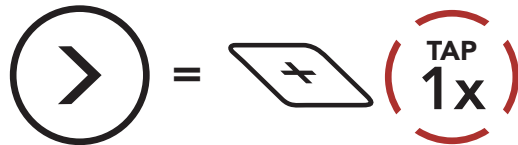

Execute Menu Options

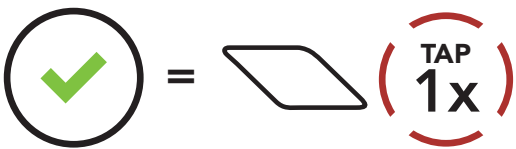

Bluetooth System Configuration Menu

Voice Configuration Menu	Tap the Center Button
Second Mobile Phone Pairing	None
Factory Reset	Execute
Exit Configuration	Execute

9.2 Software Configuration Setting

You can change the settings of the Bluetooth system through the **Sena Device Manager** or the **Sena Cycling App**.



9.2.1 Headset Language

You can select the device language. The selected language is maintained even when the Bluetooth system is rebooted.

9.2.2 Voice Prompt (Default: Enable)

You can disable **Voice Prompts** by software configuration settings, but the following voice prompts are always on.

- Bluetooth system configuration settings menu, battery level indicator

9.2.3 Advanced Noise Control™ (Always on)

The background noise is reduced during an intercom conversation.

10. TROUBLESHOOTING

10.1 Fault Reset

When the Bluetooth system is not working properly, you can easily reset the unit:

1. Locate the **pinhole reset button** below Sena logo at the back side of the helmet.
2. Gently insert a paper clip into the hole and press the **Fault Reset Button** for **1 second** with light pressure.

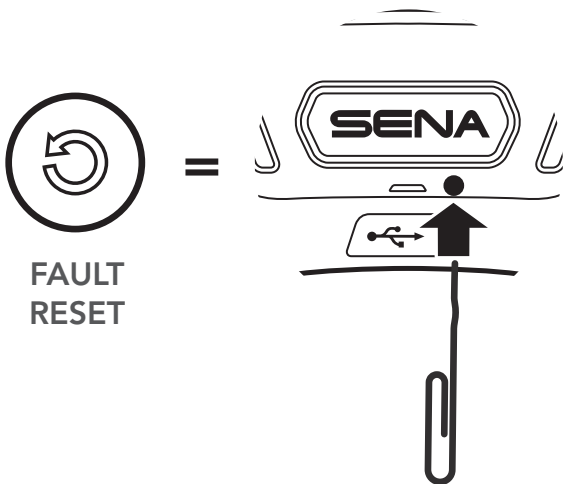

10.2 Factory Reset

To erase all of your settings and start fresh, the system can be restored to factory default settings using the **factory reset**.

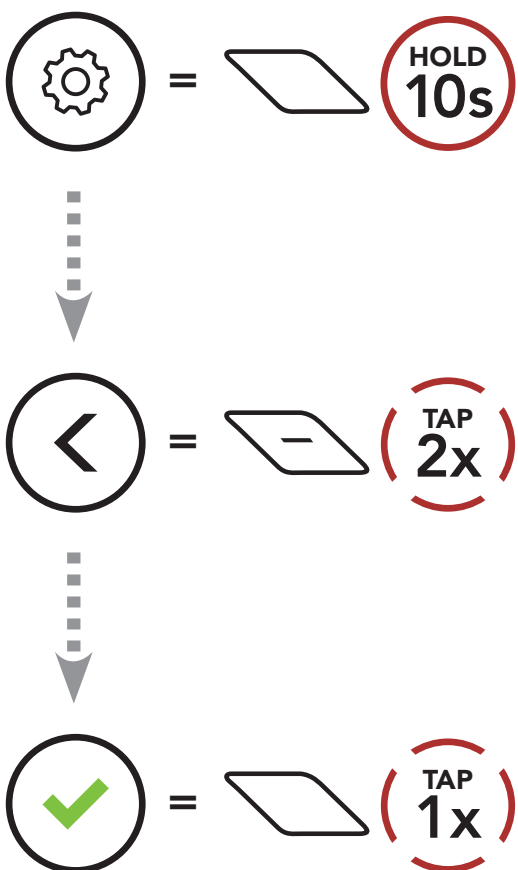

11. MAINTENANCE AND CARE

The inner lining of the helmet is completely removable. Its headliner can be washed by hand using only water, mild soap, at a maximum temperature of 30°C (86°F), and non-abrasive cloths to clean the helmet's shell, pads and retention system. Allow the padding to dry at room temperature. Store the helmet in a dry, dark, well-ventilated location, out of the reach of children and animals. High temperatures (above 110°F, 43°C) may melt the helmet's shell.

WARNING

- Never use gasoline, diesel fuel, thinners or solvents to clean the helmet. These substances can cause serious damage to the helmet, even though the resulting damage may not be visible. This helmet can be damaged by contact with common substances (for example, certain solvents (ammonia), cleaners (bleach), paints, abrasives) and this damage may not be visible to the wearer. Do not use this helmet if it has been exposed to such substances. The full safety function of the helmet can no longer be guaranteed if exposed to damaging substances.
- Do not store your helmet in your car or anywhere else near a heat source. Do not use if the shell has been melted or deformed. Always position the helmet so that it cannot fall to the floor. Damage that occurs in this way is not covered by the warranty.
- Do not attach anything to your helmet, including mirrors or lights.

The shell of this helmet is constructed of expanded polystyrene foam. Ventilation holes may allow harmful objects to pass in the helmet interior.

The protective capability of your helmet will diminish over time, dependent upon many factors such as dents, dings, and exposure to pollution, harmful chemicals and long term exposure to the sun. Sena recommends that helmets be replaced after five years.

Note: The useful life of your helmet may be less than five years as a result of exposure to sunlight, rough, handling/storage that results in dents or cuts or as a result of heavy use.



Copyright © 2022 Sena Technologies, Inc.
All rights reserved.

© 1998–2022 Sena Technologies, Inc. All rights reserved.

Sena Technologies, Inc. reserves the right to make any changes and improvements to its product without providing prior notice.

Sena™ is a trademark of Sena Technologies, Inc. or its subsidiaries in the USA and other countries. SF1™, SF2™, SF4™, SFR™, SRL™, Momentum™, Momentum INC™, Momentum Lite™, Momentum Pro™, Momentum INC Pro™, Momentum EVO™, Cavalry™, Latitude SR™, Latitude SX™, Latitude S1™, 30K™, 33i™, 50S™, 50R™, 50C™, 5S™, 5R™, 5R LITE™, 20S EVO™, 20S™, 10S™, 10C™, 10C PRO™, ProRide EVO™, 10C EVO™, 10U™, 10Upad™, 10R™, ACS10™, ACS-RAM™, C1™, 3S™, 3S PLUS™, SMH5™, SMH5-FM™, SMH5 MultiCom™, SMH10™, SMH10R™, SPH10™, SPH10H-FM™, Savage™, Prism Tube WiFi™, Prism™, Bluetooth Audio Pack for GoPro®, Impulse™, R1™, R1 EVO™, R1 EVO C™, R2™, R2 EVO™, R2X™, M1™, M1 EVO™, RUMBA™, RC1™, RC3™, RC4™, Stryker™, Handlebar Remote™, Wristband Remote™, PowerPro Mount™, Powerbank™, FreeWire™, WiFi Docking Station™, WiFi Sync Cable™, WiFi Adapter™, +mesh™, +Mesh Universal™, MeshPort Blue™, MeshPort Red™, MeshPort Black™, Econo™, OUTRUSH™, OUTRUSH R™, OUTSTAR™, OUTSTAR S™, OUTFORCE™, OUTRIDE™, EcoCom™, Parani A10™, Parani A20™, Parani M10™, pi™, Snowtalk™, Snowtalk2™, SR10™, SR10i™, SM10™, SPIDER RT1™, SPIDER ST1™, X1™, X1 Pro™, X1S™, Expand™, Expand Boom™, Bluetooth Mic & Intercom™, Tufftalk™, Tufftalk Lite™, Tufftalk M™ are trademarks of Sena Technologies, Inc. or its subsidiaries. These trademarks may not be used without the express permission of Sena.

GoPro® is a registered trademark of Woodman Labs of San Mateo, California. Sena Technologies, Inc. ("Sena") is not affiliated with Woodman Labs, Inc. The Sena Bluetooth Pack for GoPro® is an aftermarket accessory specially designed and manufactured by Sena Technologies, Inc. for the GoPro® Hero3 and Hero4 allowing for Bluetooth capabilities.

The Bluetooth® word mark and logos are owned by the Bluetooth SIG, Inc. and any use of such marks by Sena is under license. iPhone® and iPod® touch are registered trademarks of Apple Inc.

Address: 152 Technology Drive Irvine, CA 92618